

Clock Oscillator (时钟振荡器) - KD326C

Feature 特征

HCSL output with miniature package with low phase jitter 0.2ps typ. HCSL 输出, 小封装尺寸低相位抖动



Applications 应用

Mobile communications, radar navigation, digital products, HD monitoring, precision instruments 移动通信, 雷达导航, 数码产品, 高清监控, 精密仪器等

General Specifications 规格参考

PARAMETER	性能参数	数值		
Frequency Range	频率范围	13.5MHz ~ 200MHz		
Supply Voltage	供给电压	+1.8V(±10%)	+2.5V (±10%)	+3.3V(±10%)
Output Logic	输出波形	HCSL		
Frequency Tolerance	调整频差	±30ppm max		
Frequency Stability	温度频差	见下表		
Operating Temperature Range	温度范围	见下表		
Current Consumption (15pF load)	工作电流	30mA max		
Output Load	输出负载	50Ω to ground on each output		
Start-up Time	起振时间	10ms max		
Duty Cycle	占空比	45~55%		
Rise & Fall Time	上升下降时间	0.6ns max		
Output Logic High "1"	输出电平 高	400mV min, 750mV typ. -150mV~150mV	550mV~850mV	550mV~850mV
Output Logic Low "0"	输出电平 低		-150mV~150mV	-150mV~150mV
Output Voltage Swing	输出电压波动	400mV min.	500mV min.	600mV min.
RMS Phase Jitter	抖动	0.2ps typ.; 0.5ps max. [12KHz~20MHz]		
Storage Temperature Range	储存温度范围	-55°C ~ +125°C		
Aging Per Year	年老化率	±3ppm ~ ±5ppm/year		

Frequency Stability 温度频差 VS Operating Temperature Range 温度范围						
Temp. Code	Temp.\ppm	±10	±20	±30	±50	±100
B	-20~70°C	○	○	○	○	○
C	-40~85°C		○	○	○	○
D	-55~85°C			○	○	○
E	-55~105°C				○	○
F	-55~125°C					○

NOTE: Please consult for other specifications 若有其它规格需求请告知

Outline Dimensions (Unit: mm) 外形尺寸

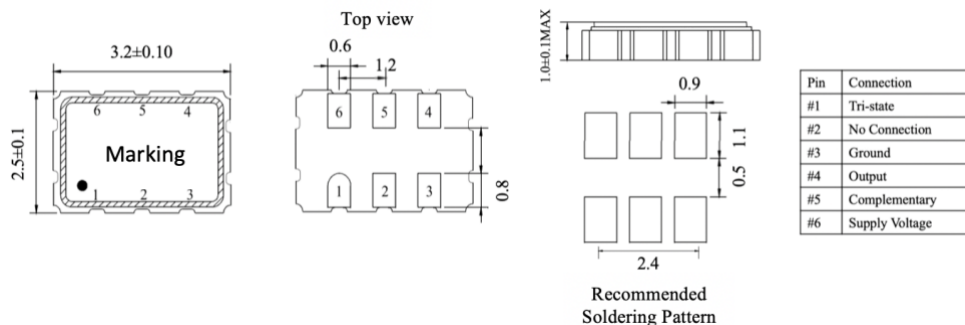

总部地址: 北京市海淀区知春路豪景大厦 B 座 802 室

公司官网: www.koan-xtal.com 联系电话: 010-62101903 传真: 010-62101561

Test Circuits and Output Waveforms 测试电路图以及输出波形

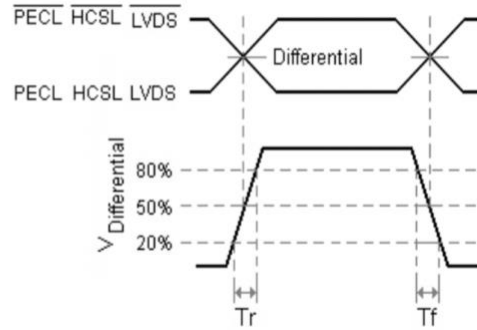
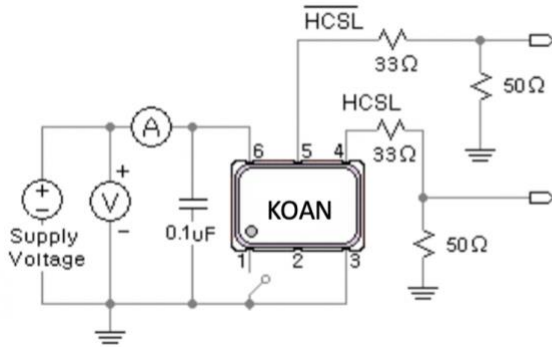

Part Number Guide 产品编号

KD326C	-	20.000	-	33	-	C	-	30	-	
封装	-	标称频率	-	工作电压	-	工作温度	-	温度频差	-	特殊要求
‘KD’:产品系列 K=KOAN; D=差分 ‘326’:封装尺寸 SMD 3.2x2.5mm 6 pad ‘C’: 输出波形 HCSL				18=1.8V 25=2.5V 33=3.3V		B: -20~+70°C C: -40~+85°C D: -55~+85°C E: -55~+105°C F: -55~+125°C		10 = ±10ppm 20 = ±20ppm 30 = ±30ppm 50 = ±50ppm 100 = ±100ppm		NS=特殊要求

Reflow Profile 回流焊

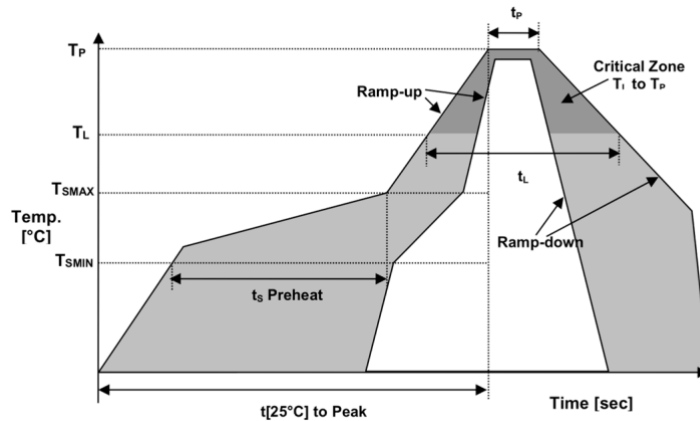

Temperature Min Preheat	最低预热温度	T_{smin}	150°C
Temperature Max preheat	最高预热温度	T_{smax}	200°C
Time (T_{smin} to T_{smax})	时间差	T_s	60~120 sec
Temperature	温度	T_L	217°C
Peak Temperature	最高温	T_p	260 °C
Ramp-up Rate	升温速度	R_{up}	3°C/sec max
Ramp-down Rate	降温速度	R_{down}	6°C/sec max
Time within 5°C of Peak Temperature	最高温度停留时间	t_p	30 sec
Time $t[25°C]$ to peak temperature	25度到最高温度时间	$t[25°C]$ to peak	480 sec
Time	时间	t_L	60~150 sec

Revision 版本

版本 Rev.	修改页 Revise Page	修改内容 Revise Contents	日期 Date	修改人 Reviser
0	N/A	Initial issue	2020.09.27	JH